

# FUNC.

WHERE FUN AND FUNCTION CONNECT



JUNE 2020

PRODUCTS AND PRICING



**CROWN**  
SURFACE SOLUTIONS

# FUNC.

Contract furniture doesn't have to be stuffy and uncreative. We know it can be stylish and modern and comfortable too. So we started making our own and never looked back.

Our unconventional designs convey that func-with-a-C feeling. Our contours and curves show us new sides to the universe. Good design goes beyond look and feel—it's also about form and function—how well something works. Good design is the presence of a force greater than ourselves in any space. It champions creativity at every corner. Every nook and cranny. Everywhere fun and function conjoin to create magic.

Quite frankly, we believe FUNC is a rare breed, but its great design belongs to anyone. We all deserve to be inspired by our environment. It's time for stuffy and uninspired contract furniture to make some space, because we're changing the landscape.



# AVAILABLE COLOURS AND FINISHES

Func products are constructed from the highest quality polyethylene terephthalate or P.E.T. An ideal material for reducing ambient noise and sound within noisy environments.

When applicable, wood accents are available in light or dark finish. A wood colour selection must be made when ordering.



Mirang Marker Board

**FUNC.**

## COLOURS



## FINISHES

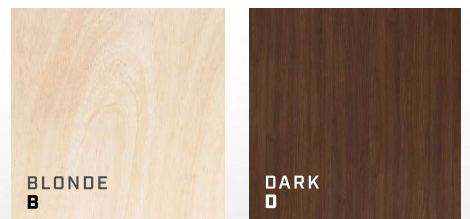

# FLOOR SCREENS

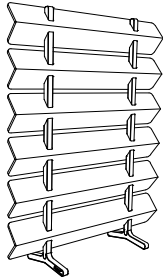

## ALINTA

48" w x 61" h x 15" d  
\$2,240

FALNFS4861

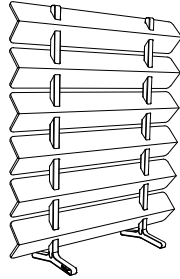

## ALINTA

72" w x 61" h x 15" d  
\$2,994

FALNFS7261

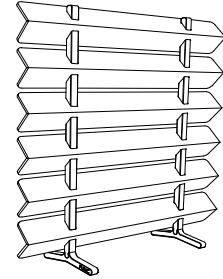

## ALINTA

96" w x 61" h x 15" d  
\$3,065

FALNFS9661

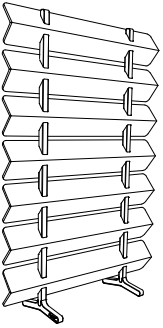

## ALINTA

48" w x 72" h x 15" d  
\$2,372

FALNFS4872

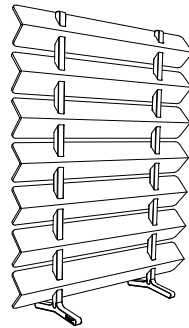

## ALINTA

72" w x 72" h x 15" d  
\$3,197

FALNFS7272

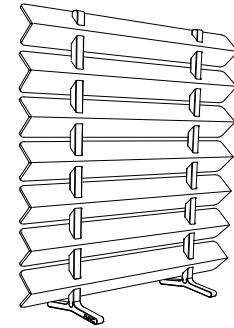

## ALINTA

96" w x 72" h x 15" d  
\$3,296

FALNFS9672

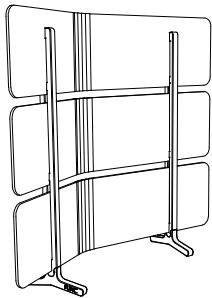

## MALLEE

60" w x 54" h x 14.5" d  
\$3,136

FMALFS6054

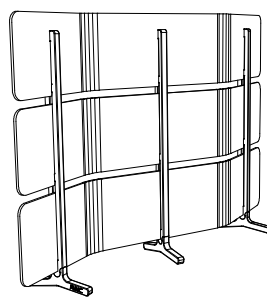

## MALLEE

84" w x 54" h x 14.5" d  
\$3,768

FMALFS8454

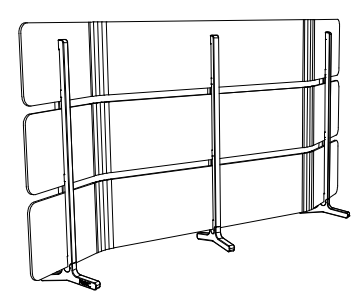

## MALLEE

108" w x 54" h x 14.5" d  
\$3,914

FMALFS10854

# FLOOR SCREENS

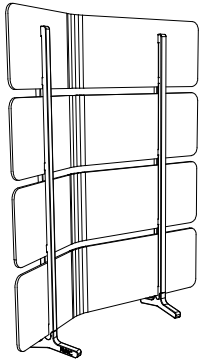

## MALLEE

60" w x 72" h x 14.5" d  
\$3,537

FMALFS6072

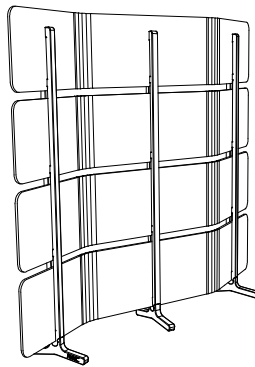

## MALLEE

84" w x 72" h x 14.5" d  
\$4,268

FMALFS8472

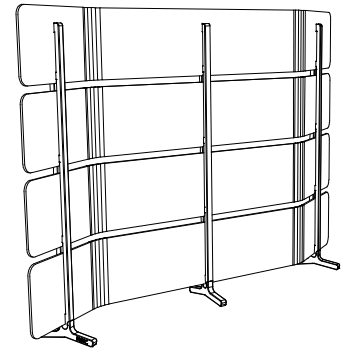

## MALLEE

108" x 72" h x 14.5" d  
\$4,480

FMALFS10872

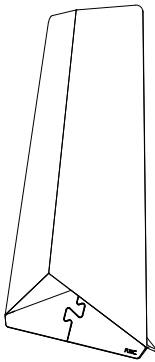

## YAKKA

42" w x 72" h x 31" d  
\$2,089

FYAKFS4272

# DESK SCREENS

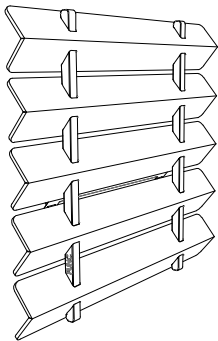

## ALINTA

48" w x 43" h x 8" d  
\$2,042

FALNFS4843

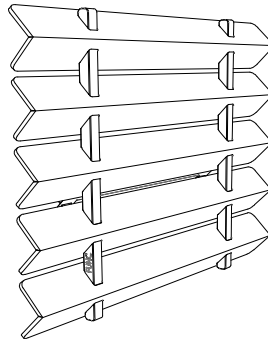

## ALINTA

60" w x 43" h x 8" d  
\$2,631

FALNFS6043

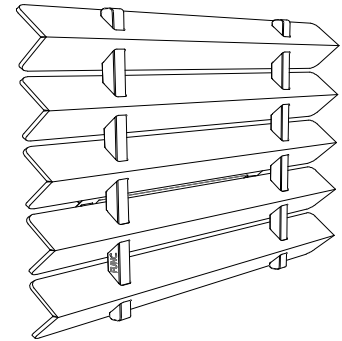

## ALINTA

72" w x 43" h x 8" d  
\$3,141

FALNFS7243

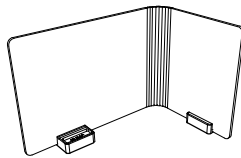

## MALLEE

48" w x 21" h x 20" d  
\$655

FMALDS4821

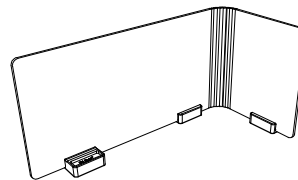

## MALLEE

60" w x 21" h x 20" d  
\$910

FMALDS6021

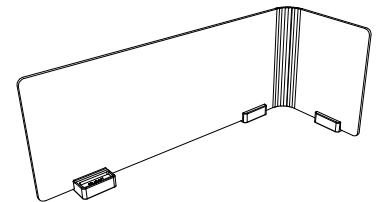

## MALLEE

72" w x 21" h x 20" d  
\$1,646

FMALDS7221

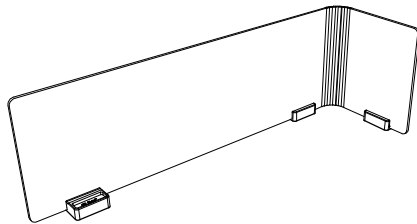

## MALLEE

84" w x 21" h x 20" d  
\$1,688

FMALDS8421

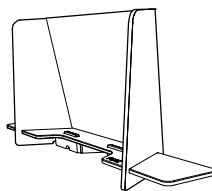

## YAKKA

48" w x 21" h x 9" d  
\$1,217

FYAKDS4821

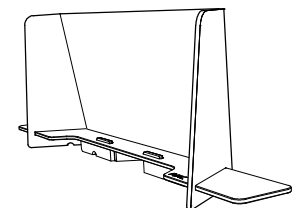

## YAKKA

60" w x 21" h x 9" d  
\$1,481

FYAKDS6021

# DESK SCREENS

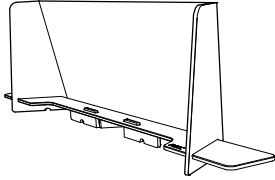

---

## YAKKA

72" w x 21" h x 9" d  
\$1,509

FYAKDS7221

# PRIVACY HOODS

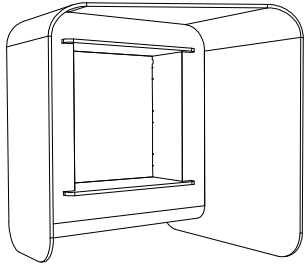

**LINGO (RIGHT)**

33"w x 36"h x 30"d  
\$2,834

FLPH3336R

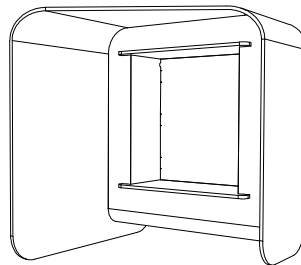

**LINGO (LEFT)**

33"w x 36"h x 30"d  
\$2,834

FLPH3336L

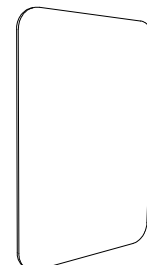

**LINGO WALL PANEL**

24"w x 36"h x 1"d  
\$585

FLWP2436

# VERTICAL DIVIDERS

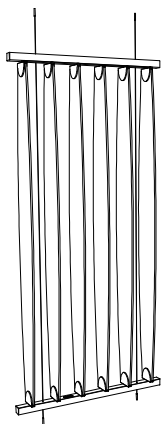

**BUNJI**

4'w x 8'h x 9"d  
\$2,787

FBSS84

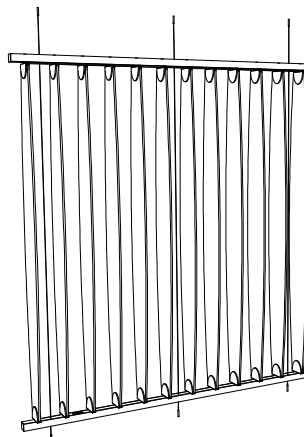

**BUNJI**

8'w x 8'h x 9"d  
\$4,112

FBSS88



# MARKER BOARDS

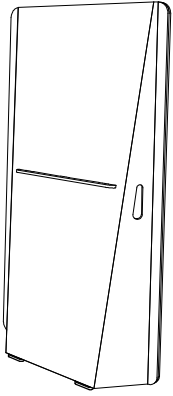

---

## MIRANG

42"w x 72"h x 17"d  
\$3,098

FMIRFS4272

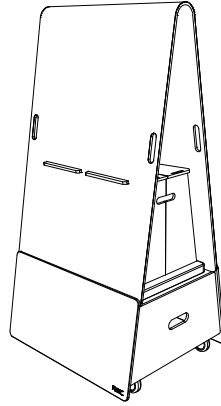

---

## YABBY

36"w x 70"h x 30"d  
\$4,933

FYMMB3670SS



---

## FUNC MARKER BOARD

23"w x 32"h x .5"d  
\$490

FWBMAG3234

**FUNC.**

# SOCIAL RESPONSIBILITY

A belief in the power of creativity is at the heart of Func. We champion great design, and work with forward thinking visionaries from all walks of life to help shape our products and our perspective and drive meaningful solutions. We are passionate in our belief that great design doesn't exclude anyone.

## TO BE GREAT YOU HAVE TO RETHINK EVERYTHING

To truly be different, a company must intentionally seek out new ways of delivering ideas, products and solutions to the market, in a thoughtful and considerate manner. Foundationally, FUNC. is an imaginative brand that is based on five-key design, social and business objectives.

1) **Take care of our planet:** All FUNC. solutions are constructed with PET felt, which is a type of plastic found in water or soda bottles. This material offers great acoustic performance and can be 100% recycled at the end of its lifecycle. It can also be shaped, cut and processed with minimal expenditure of energy or the use of heavy industrial equipment, resulting in minimal CO2 emissions. In fact, the FUNC. team is vigilant in the stewardship of materials and resources, which shapes the way our products are designed, specified, shipped and installed.

2) **Solutions ship flat and are easily assembled:** Freight and transportation costs continue to increase annually, while paper and paperboard products, according to a 2017 EPA summary, represent 25% of the materials that go into landfills annually.

With this in mind, we designed FUNC. solutions to ship flat, thereby requiring minimal packaging and reducing the amount of waste associated with the shipment, delivery and installation of our solutions. In the case of FUNC. "Less is More". FUNC. products are also incredibly easy to plan and install. Which saves not only time, but man hours of labor.

3) **Encourage remote employees and teams:** The majority of FUNC. associates work from their homes in remote locations across the U.S. and the globe. We understand the value of technology within a shrinking world and believe that people can come together leveraging a wide range of communications tools and still be incredibly productive, without driving to an office every day. We also believe in a balance between work life and home life. The best and most innovative ideas come from unique points of view. By encouraging our associates to work from home, we can leverage a broader range of personal experience to shape our products and our brand. On average, our associates save 2 hours of their day by not driving to and from work, which not only saves them time, it also is good for our planet.

4) **Value partners and relationships:** Our customers are more than the people that buy our products.

They are valued partners that provide us with feedback and ideas that we leverage within virtually every aspect of our business. We listen, learn and respond quickly to the needs of the market with the goal of consistently providing innovative concepts and solutions. With this in mind, we strive to reduce complexity while fostering creativity at a pace that surpasses the industry standards.

## TOTAL MSW GENERATED BY MATERIAL, 2017 [267.8 MILLION TONS]

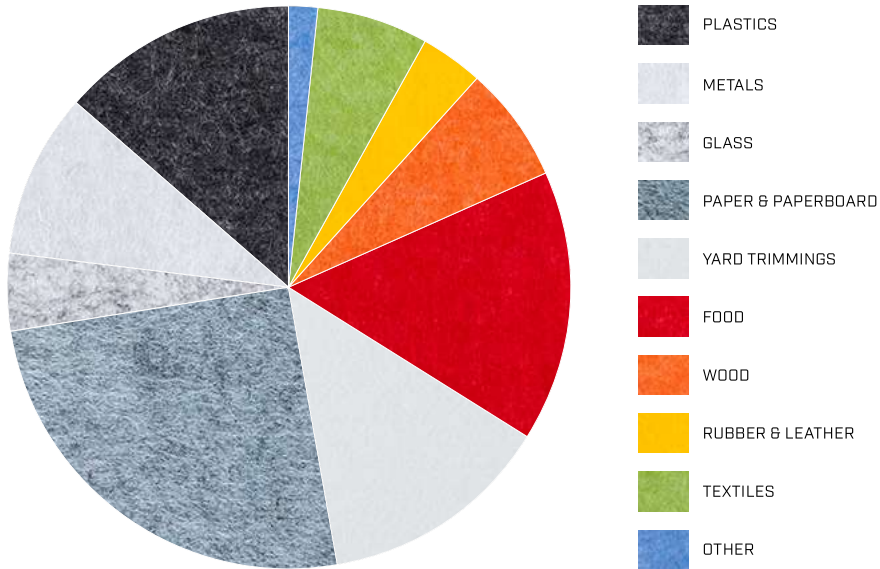

**FUNC.**

# LIMITED & EXCLUSIVE WARRANTY

Baresque Australia Pty Ltd warrants to the purchaser that for a period of five years after delivery, our products will be free of manufacturing defects. The purchaser's sole and exclusive remedy shall be replacement of defective product or refund of the purchase price at this company's option.

This limited warranty does not cover and expressly excludes any claim, damage, loss or expense arising out of or relating to: A) accident or vandalism, B) abuse, misuse or unapproved use of the product, C) installation contrary to the hanging instructions and good installation practices D) mould or mildew E) abnormal conditions of use F) improper maintenance (please see separate instructions) or equipment and G) design, installation or construction deficiencies of any kind or nature.

This limited warranty is the sole and exclusive warranty given by Baresque with respect to the above mentioned product. All other representations and warranties, express or implied are expressly disclaimed, included any implied warranties of merchantability, fitness for a particular purpose or claimed to arise from course of dealing or usage in trade practice.

In no event will Baresque be liable for indirect, consequential, special or exemplary damages, whether based in contract, tort, strict liability, warranty or otherwise. This exclusive warranty shall supersede and control any other representations and warranties with respect to this product.

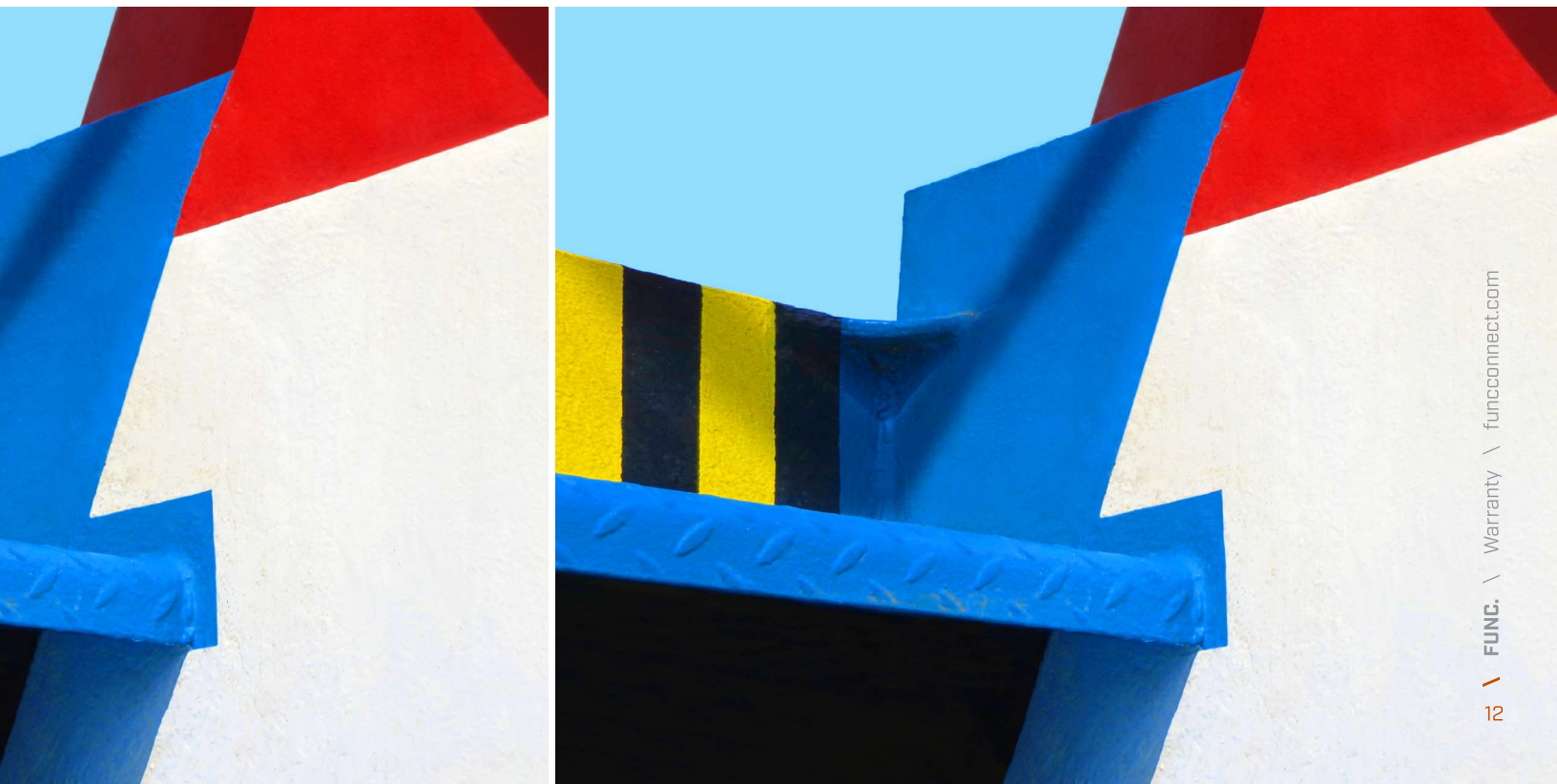

**FUNC.**

# CLEANING AND MAINTENANCE

They say cleanliness is next to godliness. We understand the need to feel safe and secure within a crowded environment. That's why Func endorses cleaning practices that protect our customers. Vacuum or use compressed air to remove dust that may collect over time. The use of a diluted bleach solution (one cup of bleach to five gallons of water) may be used to clean the felt surfaces of Func. Our solutions are not only visually compelling, they are also incredibly durable.



# CONTACT

[funcconnect.com](http://funcconnect.com)



[crownsurfacesolutions.com](http://crownsurfacesolutions.com)  
[info@crownsurfacesolutions.com](mailto:info@crownsurfacesolutions.com)



# FUNC.

WHERE FUN AND FUNCTION CONNECT



ALINTA

FLOOR AND DESK SCREENS

# FUNC.

Contract furniture doesn't have to be stuffy and uncreative. We know it can be stylish and modern and comfortable too. So we started making our own and never looked back.





**FUNC.**

# ALINTA

Alinta has the screens you need for dividing personal and team spaces. Noisy environments don't stand a chance against our modern floor and desk screens. The vertical supports uphold sleek design, easy on the eyes, and never obtrusive. Alinta combines acoustic materials with wood accents seamlessly, while you work or play. High quality begets high quality, and creative work environments should be no exception.



## DESIGNER PAUL JAMES

Paul James is an award winning designer and inventor with a reputation for both right and left-brain insight. He entered college to study engineering and emerged with degrees in math and economics. A graduate degree in industrial design led to leadership positions for several A list furniture companies. In 2002 he opened his own consultancy in Minneapolis specializing in product design and new venture start-ups. His process is equal parts head and hand, CAD and crayon, coffee and cocktail. Whether designing furniture, outdoor gear, or parametric fabrication systems, James' mantra is reason in every function and art in every detail.



# AVAILABLE COLOURS AND FINISHES

Alinta is constructed from the highest quality polyethylene terephthalate or P.E.T. An ideal material for reducing ambient noise and sound within noisy environments.

Alinta is available with light or dark wood vertical supports and bases. A wood colour selection must be made when ordering.



**FUNC.**

## COLOURS

FOSSIL FL	SUNSHINE SS	FROST FT
GREIGE GR	MANDARINE MN	CHAMBRAY CH
CADET CT	OCHRE OE	SMOKE SE
SKY SY	BARK BR	PEWTER PW
COBALT CB	ECRU EC	SLATE SL
MALACHITE MA	LINEN LN	TAR TR
GRASS GS	IVORY IY	

## FINISHES

BLONDE B	DARK D
-------------	-----------

# FLOOR SCREENS

A floor screen that reaches for the stars with you is a companion, without a doubt. Alinta floor screens are proof that design can be functional AND look good while doing it. Combining the finest acoustic materials with wood accents brings you ultimate ambient noise reduction for maximum privacy and uninterrupted workflow. Divide any personal or team space with the Alinta floor screen and conquer the day.

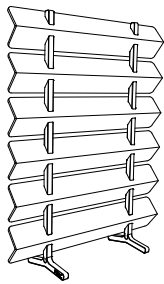

48" w x 61" h x 15" d

FALNFS4861

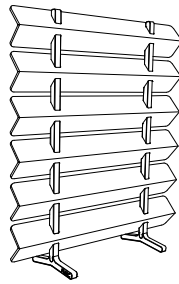

72" w x 61" h x 15" d

FALNFS7261

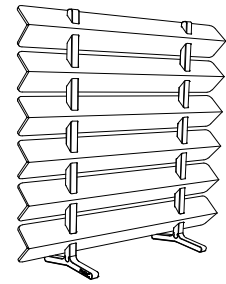

96" w x 61" h x 15" d

FALNFS9661

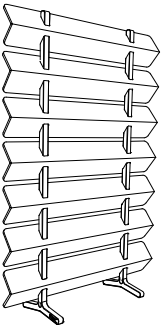

48" w x 72" h x 15" d

FALNFS4872

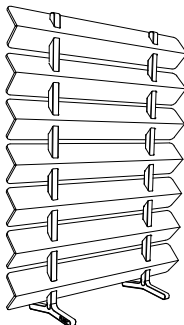

72" w x 72" h x 15" d

FALNFS7272

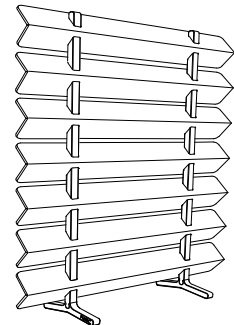

96" w x 72" h x 15" d

FALNFS9672

# DESK SCREENS

The Alinta Desk Screen keeps creative environments thriving by reducing ambient sounds. The wood accents and acoustic materials create a killer combo in both design and function. The integrated cable management feature brings an extra layer of organization with simple and intuitive design. Peace of mind comes with the Alinta territory so that you can do what you do.

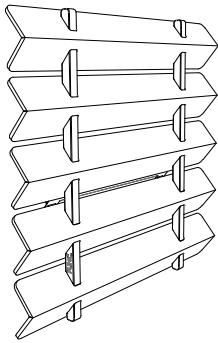

48" W X 43" H X 8" D

FALNDS4843

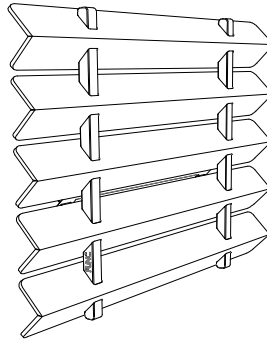

60" W X 43" H X 8" D

FALNDS6043

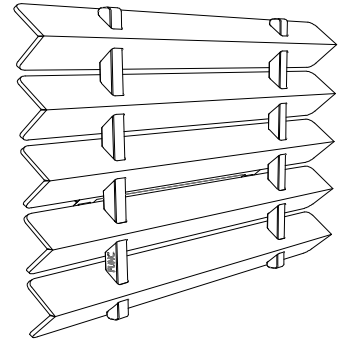

72" W X 43" H X 8" D

FALNDS7243

# CONTACT

[funconnect.com](http://funconnect.com)



[crownsurfacesolutions.com](http://crownsurfacesolutions.com)  
[info@crownsurfacesolutions.com](mailto:info@crownsurfacesolutions.com)



# FUNC.

WHERE FUN AND FUNCTION CONNECT



## MALLEE

FLOOR AND DESK SCREENS



**CROWN**  
SURFACE SOLUTIONS



# FUNC.

Contract furniture doesn't have to be stuffy and uncreative. We know it can be stylish and modern and comfortable too. So we started making our own and never looked back.

**FUNC.**

# MALLEE

It's about opening up. Warm welcomes in open plan settings. It's not everyone's forte but it's certainly Mallee's, with floor and desk screens that humbly do their thing so that you can do yours. Creative environments work best when users have flexibility and order, and Mallee's bendable, wrap-around designs give maximum privacy control. Team spaces, personal spaces—you call the shots and shape your space and your time how you want. Place Mallee's modern design anywhere and prepare for sound-reduction that's so quiet, you never even have to think about it.



## DESIGNER PAUL JAMES

Paul James is an award winning designer and inventor with a reputation for both right and left-brain insight. He entered college to study engineering and emerged with degrees in math and economics. A graduate degree in industrial design led to leadership positions for several A list furniture companies. In 2002 he opened his own consultancy in Minneapolis specializing in product design and new venture start-ups. His process is equal parts head and hand, CAD and crayon, coffee and cocktail. Whether designing furniture, outdoor gear, or parametric fabrication systems, James' mantra is reason in every function and art in every detail.





# AVAILABLE COLOURS AND FINISHES

Mallee is constructed from the highest quality polythylene terephthalate or P.E.T. An ideal material for reducing ambient noise and sound within noisy environments.

Mallee is available with light or dark wood vertical supports and bases. A wood colour selection must be made when ordering.

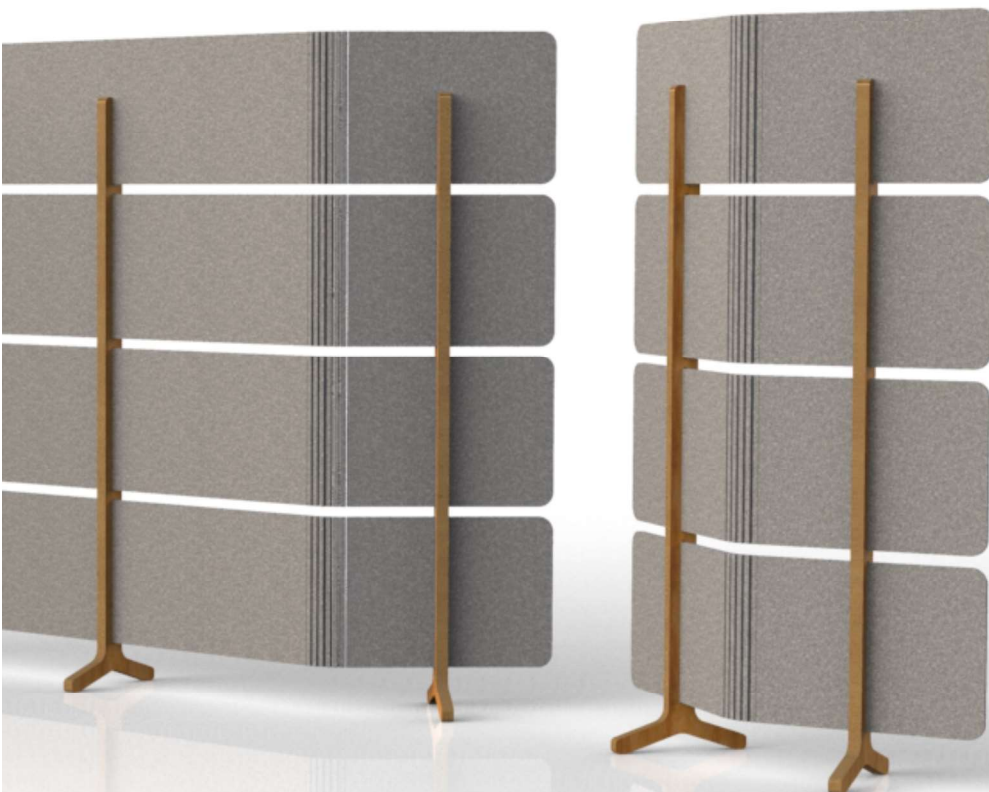

## COLOURS

FOSSIL FL	SUNSHINE SS	FROST FT
GREIGE GR	MANDARINE MN	CHAMBRAY CH
CADET CT	OCHRE OE	SMOKE SE
SKY SY	BARK BR	PEWTER PW
COBALT CB	ECRU EC	SLATE SL
MALACHITE MA	LINEN LN	TAR TR
GRASS GS	IVORY IY	

## FINISHES

BLONDE B	DARK D
-------------	-----------

# FLOOR SCREENS

Be the center of your own universe. Mallee is a user-controlled floor screen designed for privacy, flexibility, and ease-of-use. Wood vertical posts provide a substantive look and feel while a lightweight design offers shapeshifting fun. Users can easily and quickly form a “U,” “S,” or in-line shapes for various levels of personal and team privacy. Shape your day with Mallee’s floor screen. Your workflow will thank you.

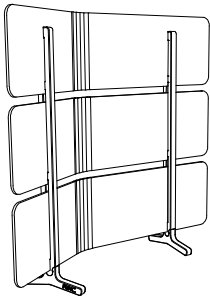

**60" w x 54" h x 14.5" d**

FMALFS6054

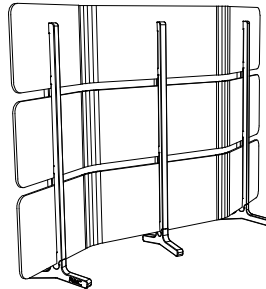

**84" w x 54" h x 14.5" d**

FMALFS8454

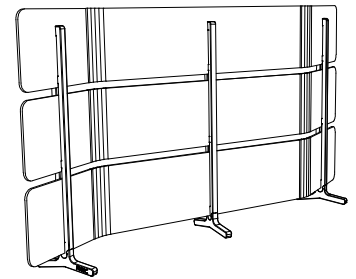

**108" w x 54" h x 14.5" d**

FMALFS10854

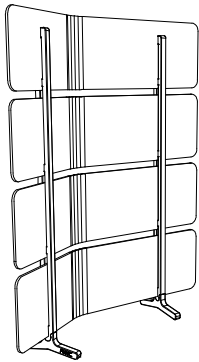

**60" w x 72" h x 14.5" d**

FMALFS6072

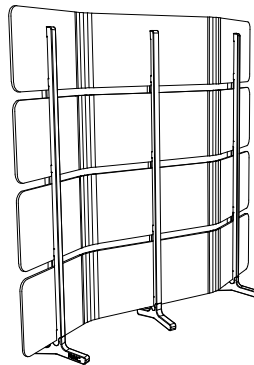

**84" w x 72" h x 14.5" d**

FMALFS8472

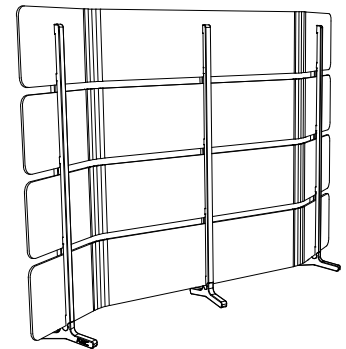

**108" w x 72" h x 14.5" d**

FMALFS10872

# DESK SCREENS

Size doesn't matter, or it does. That depends on you, and however you want to use Mallee, a desk screen that will situate you snugly in whatever place you want to be. We're talking creativity. Flexibility. Ultimate ease-of-use. Mallee does not require a single attachment for your desk or work surface. It simply rests wherever you place it for fast and convenient installation. The integrated accessories tray within the wood base design give this user-designed beauty a touch of understated complexity.

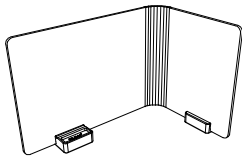

48" w x 21" h x 20" d

FMALDS4821

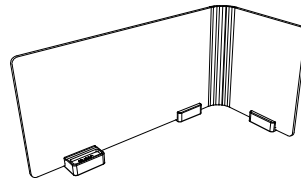

60" w x 21" h x 20" d

FMALDS6021

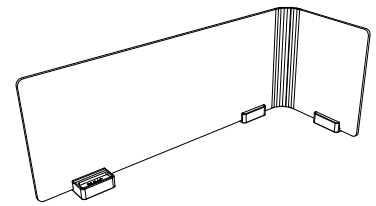

72" w x 21" h x 20" d

FMALDS7221

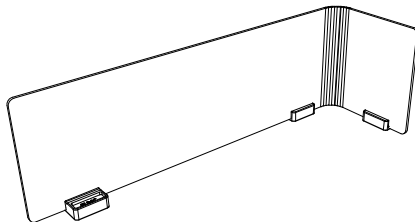

84" w x 21" h x 20" d

FMALDS8421

# CONTACT

[funconnect.com](http://funconnect.com)



**CROWN**  
SURFACE SOLUTIONS

[crownsurfacesolutions.com](http://crownsurfacesolutions.com)

[info@crownsurfacesolutions.com](mailto:info@crownsurfacesolutions.com)



# FUNC.

WHERE FUN AND FUNCTION CONNECT



MIRANG

FLOOR SCREENS



CROWN  
SURFACE SOLUTIONS

# FUNC.

Contract furniture doesn't have to be stuffy and uncreative. We know it can be stylish and modern and comfortable too. So we started making our own and never looked back.

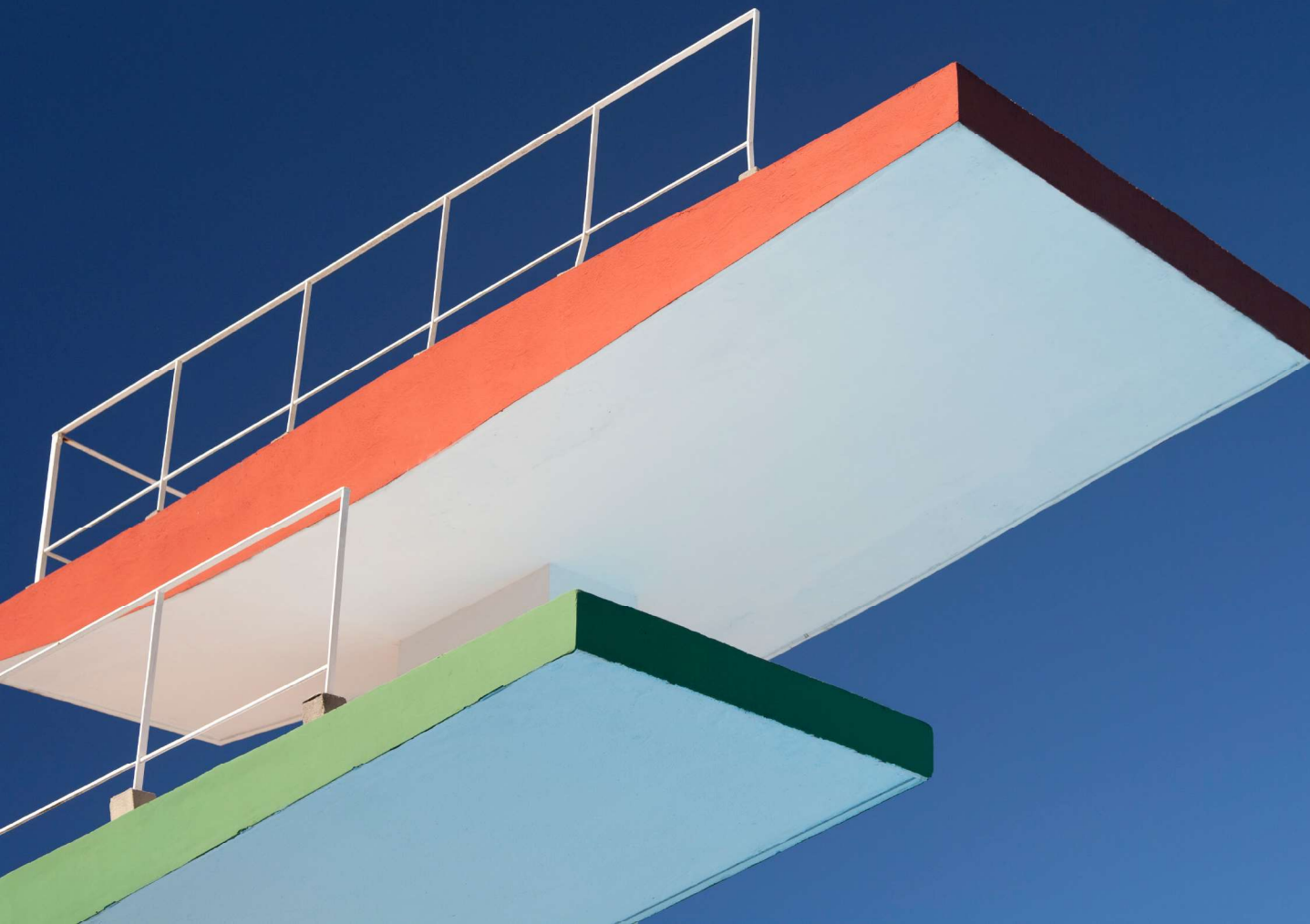

**FUNC.**

# MIRANG

Functionality with flair. With a poster board shelf and an integrated magnetic marker surface, it's hard not to want to be around this multifaceted product all the time. Mirang's unique portable "fold and go" design gives users full control. Quickly fold, flatten, and store when not in use. The integrated posting shelf, which supports flip charts and easel style poster boards, makes this floor screen an ideal tool for sharing ideas and connecting teams. All in the comfort of your creative workspace whenever you need.



## DESIGNER PAUL JAMES

Paul James is an award winning designer and inventor with a reputation for both right and left-brain insight. He entered college to study engineering and emerged with degrees in math and economics. A graduate degree in industrial design lead to leadership positions for several A list furniture companies. In 2002 he opened his own consultancy in Minneapolis specializing in product design and new venture start-ups. His process is equal parts head and hand, CAD and crayon, coffee and cocktail. Whether designing furniture, outdoor gear, or parametric fabrication systems, James' mantra is reason in every function and art in every detail.



# AVAILABLE COLOURS AND FINISHES

Mirang is constructed from the highest quality polyethylene terephthalate or P.E.T. An ideal material for reducing ambient noise and sound within noisy environments.

Mirang is available with light or dark wood vertical supports and bases. A wood colour selection must be made when ordering.



## COLOURS

FOSSIL FL	SUNSHINE SS	FROST FT
GREIGE GR	MANDARINE MN	CHAMBRAY CH
CADET CT	OCHRE OE	SMOKE SE
SKY SY	BARK BR	PEWTER PW
COBALT CB	ECRU EC	SLATE SL
MALACHITE MA	LINEN LN	TAR TR
GRASS GS	IVORY IY	

## FINISHES

BLONDE B	DARK D
-------------	-----------



# FLOOR SCREENS

The Mirang floor screen is a real pro at dividing personal and team spaces, without picking sides. Creative environments finally have the room to be themselves when Mirang's floor screen is in use, reducing distracting noises to near nothing. Imagine a marriage of smart design and modern materials and that's Mirang, truly unique, a solution, shipping flat, assembling quickly, easily without tools. That's more time for you to create, curate, dream—whatever it is you do best—Mirang's there for all of it.

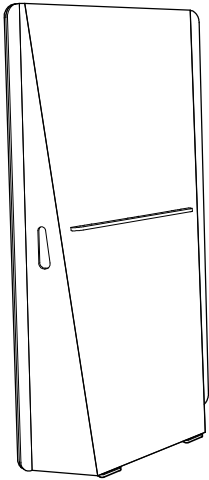

---

42" <sub>W</sub> X 72" <sub>H</sub> X 17.32" <sub>D</sub>

FMIRFS4272

# CONTACT

[funconnect.com](http://funconnect.com)



[crownsurfacesolutions.com](http://crownsurfacesolutions.com)  
[info@crownsurfacesolutions.com](mailto:info@crownsurfacesolutions.com)



# FUNC.

WHERE FUN AND FUNCTION CONNECT

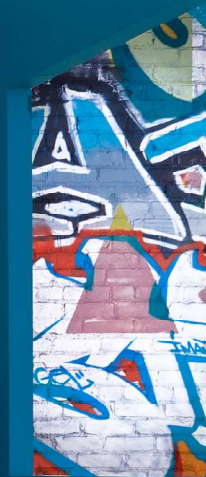

## YAKKA

FLOOR AND DESK SCREENS



**CROWN**  
SURFACE SOLUTIONS

# FUNC.

Contract furniture doesn't have to be stuffy and uncreative. We know it can be stylish and modern and comfortable too. So we started making our own and never looked back.

**FUNC.**

# YAKKA

Yakka's modern form ships flat and assembles quickly, without tools. A design so lightweight and versatile you can put it in any workspace yourself. No mechanical connection required. You're adding more, and somehow seeing less, thanks to Yakka's functional utility which frees valuable work surface space. A real beauty how that works, not to mention the increased privacy and well-organized office space that'll be your company to keep. Ambient noises will be reduced and you can reconfigure to support whatever level of privacy you're feeling.



## DESIGNER PAUL JAMES

Paul James is an award winning designer and inventor with a reputation for both right and left-brain insight. He entered college to study engineering and emerged with degrees in math and economics. A graduate degree in industrial design lead to leadership positions for several A list furniture companies. In 2002 he opened his own consultancy in Minneapolis specializing in product design and new venture start-ups. His process is equal parts head and hand, CAD and crayon, coffee and cocktail. Whether designing furniture, outdoor gear, or parametric fabrication systems, James' mantra is reason in every function and art in every detail.



# AVAILABLE COLOURS AND FINISHES

Yakka is constructed from the highest quality polyethylene terephthalate or P.E.T. An ideal material for reducing ambient noise and sound within noisy environments.

Yakka is available with light or dark wood support base. A wood colour selection must be made when ordering.



## COLOURS

FOSSIL FL	SUNSHINE SS	FROST FT
GREIGE GR	MANDARINE MN	CHAMBRAY CH
CADET CT	OCHRE OE	SMOKE SE
SKY SY	BARK BR	PEWTER PW
COBALT CB	ECRU EC	SLATE SL
MALACHITE MA	LINEN LN	TAR TR
GRASS GS	IVORY IY	

## FINISHES

BLONDE B	DARK D
-------------	-----------

# FLOOR SCREEN

This floor screen with a wood base turns any open-space setting into a visual privacy haven. With a lightweight design, user control is maximized, and reconfiguring to support the level of privacy you want is quick and easy. Yakka's compelling form suggests movement while standing still. A visual stand-out that's also structurally supportive, stable, and sound-reducing. So you can focus on the beauty of exactly what's in front of you.

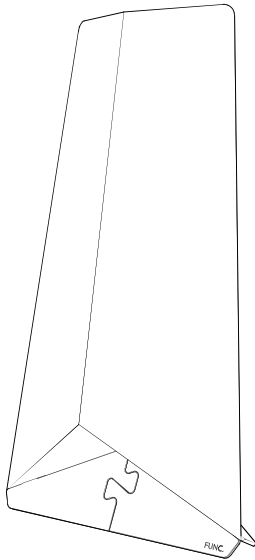

---

42" W X 72" H X 31" D

FYAKFS4272

# DESK SCREENS

Walls can take a long time to build, but the Yakka desk screens take only moments to add to any space. Ships flat, assembles quickly, no tools needed, and all the privacy and noise reduction you could ask for. Tight spaces get a new, more open look. With an integrated power and cable management system unsightly cords and cables still get to do their job, without you even knowing they're there. "Smart" shelf? Check. Designed to support a wide range of electronic devices and personal items, Yakka's desk screen bumps up visual and acoustic privacy, helps you stay focused and organized at the task at hand, and looks stylish while doing it.

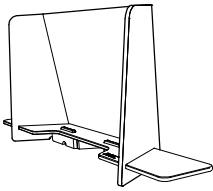

48" w x 21" h x 9" d

FYAKDS4821

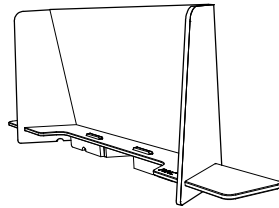

60" w x 21" h x 9" d

FYAKDS6021

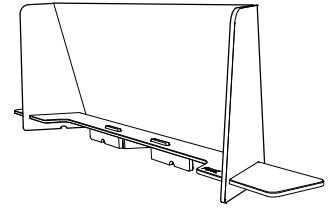

72" w x 21" h x 9" d

FYAKDS7221



# CONTACT

[funconnect.com](http://funconnect.com)



**CROWN**  
SURFACE SOLUTIONS

[crownsurfacesolutions.com](http://crownsurfacesolutions.com)

[info@crownsurfacesolutions.com](mailto:info@crownsurfacesolutions.com)



# FUNC.

WHERE FUN AND FUNCTION CONNECT



BUNJI

VERTICAL SPACE DIVIDERS



CROWN  
SURFACE SOLUTIONS

# FUNC.

Contract furniture doesn't have to be stuffy and uncreative. We know it can be stylish and modern and comfortable too. So we started making our own and never looked back.

**FUNC.**

# BUNJI

Bunji is conscious of space and sound. Hear what you want and see what you want. Truly a unique solution that ships flat and assembles quickly without tools. Minimal packaging materials and installation costs. Bunji is saving all of that power and energy for you. Designed to encourage user control space division, it's about what makes you feel comfy. Made from the highest quality P.E.T. to reduce sounds in collaborative environments, Bunji, with its rotating vertical louvers and universal ceiling mounts for ceiling heights up to 10', is designed to encourage user space control division to maximum capacity.



## DESIGNER PAUL JAMES

Paul James is an award winning designer and inventor with a reputation for both right and left-brain insight. He entered college to study engineering and emerged with degrees in math and economics. A graduate degree in industrial design lead to leadership positions for several A list furniture companies. In 2002 he opened his own consultancy in Minneapolis specializing in product design and new venture start-ups. His process is equal parts head and hand, CAD and crayon, coffee and cocktail. Whether designing furniture, outdoor gear, or parametric fabrication systems, James' mantra is reason in every function and art in every detail.

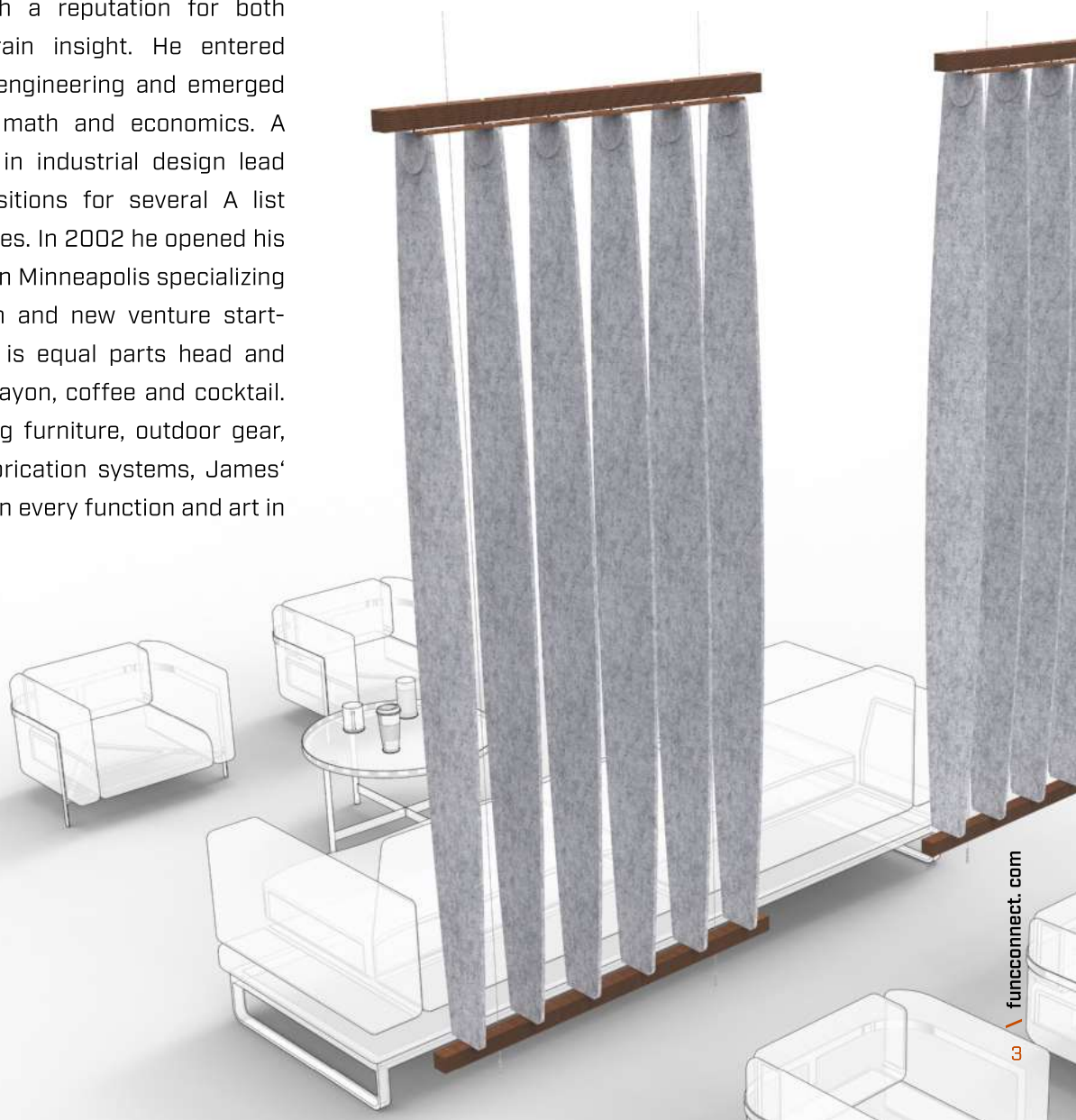

# AVAILABLE COLOURS AND FINISHES

Bunji is constructed from the highest quality polythylene terephthalate or P.E.T. An ideal material for reducing ambient noise and sound within noisy environments.

Bunji is available with light or dark wood vertical supports and bases. A wood colour selection must be made when ordering.



## COLOURS



## FINISHES

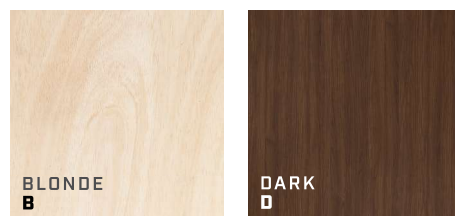

# SPACE DIVIDERS

Finally, a space divider that's easy on the eyes. High quality P.E.T. material for ultimate sound reduction. Toolless assembly. Your privacy is in your control with rotating vertical louvers that turn in unison, giving you whatever level of solitude you need. A universal ceiling mount that accommodates ceiling heights up to 10' makes Bunji great for any space. A real pro at dividing open settings in the best of ways.

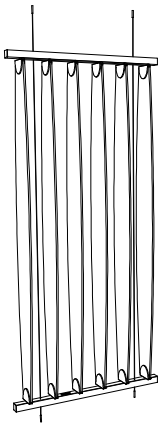

4'w X 8'h X 3',4.5"d

FBSS84

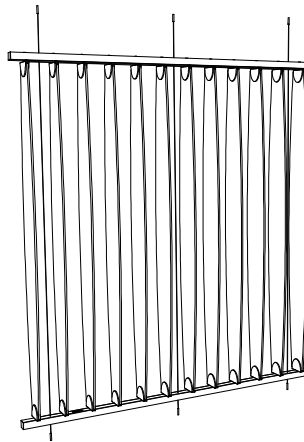

8'w X 8'h X 3',4.5"d

FBSS88

# CONTACT

[funconnect.com](http://funconnect.com)



**CROWN**  
SURFACE SOLUTIONS

[crownsurfacesolutions.com](http://crownsurfacesolutions.com)

[info@crownsurfacesolutions.co](mailto:info@crownsurfacesolutions.co)



# FUNC.

WHERE FUN AND FUNCTION CONNECT



YABBY

MOBILE MARKER SURFACE



CROWN  
SURFACE SOLUTIONS



# FUNC.

Contract furniture doesn't have to be stuffy and uncreative. We know it can be stylish and modern and comfortable too. So we started making our own and never looked back.

**FUNC.**

# YABBY

Yabby doesn't care if you're gabby. Noise reduction materials let you engage in your work while keeping environments still highly collaborative. Creation is the goal with the markable/erasable surfaces on each side of the mobile marker board, and an acoustic surface on the other side. We've got your needs covered on both sides. Functionality and utility are good to go too—a removable marker easel that turns into a bench for you to sit and write, integrated storage for markers and erasers, and two large drawers for whatever else you'll need. This is your place to create and share ideas, ready and accessible for making your magic.



## DESIGNER PAUL JAMES

Paul James is an award winning designer and inventor with a reputation for both right and left-brain insight. He entered college to study engineering and emerged with degrees in math and economics. A graduate degree in industrial design lead to leadership positions for several A list furniture companies. In 2002 he opened his own consultancy in Minneapolis specializing in product design and new venture start-ups. His process is equal parts head and hand, CAD and crayon, coffee and cocktail. Whether designing furniture, outdoor gear, or parametric fabrication systems, James' mantra is reason in every function and art in every detail.



# AVAILABLE COLOURS AND FINISHES

Yabby is constructed from the highest quality polyethylene terephthalate or P.E.T. An ideal material for reducing ambient noise and sound within noisy environments.

Yabby is available with a light or dark wood base. A wood colour selection must be made when ordering.



## COLOURS

FOSSIL FL	SUNSHINE SS	FROST FT
GREIGE GR	MANDARINE MN	CHAMBRAY CH
CADET CT	OCHRE OE	SMOKE SE
SKY SY	BARK BR	PEWTER PW
COBALT CB	ECRU EC	SLATE SL
MALACHITE MA	LINEN LN	TAR TR
GRASS GS	IVORY IY	

## FINISHES

BLONDE B	DARK D
-------------	-----------

# MARKER BOARDS

Equipped and ready for your creative ideas. Markable/erasable surface on each side and an acoustic surface on the opposite side for noise reduction. Removable marker easel allows the base to become a mobile benching surface for temporary seating and team interaction so you can park it when you need to. Fully integrated storage for markers and erasers. Two large drawers for increased functional utility. Wherever you go to work or create, Yabby's got you.

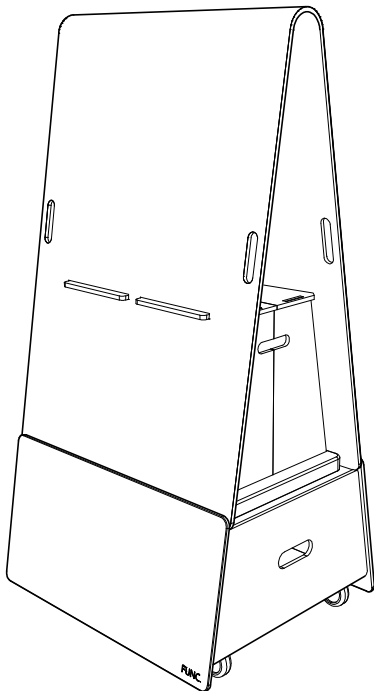

---

36" X 70" H X 30" D

FYMMB3670SSF

# CONTACT

[funconnect.com](http://funconnect.com)



[crownsurfacesolutions.com](http://crownsurfacesolutions.com)  
[info@crownsurfacesolutions.com](mailto:info@crownsurfacesolutions.com)



# FUNC.

WHERE FUN AND FUNCTION CONNECT



LINGO

PRIVACY HOODS

# FUNC.

Contract furniture doesn't have to be stuffy and uncreative. We know it can be stylish and modern and comfortable too. So we started making our own and never looked back.

**FUNC.**

# LINGO

It's cozy, for starters. Constructed from the highest quality polyethylene terephthalate [we just call it P.E.T.], Lingo is designed to reduce ambient sounds in noisy environments. Convenient, short term private conversations will finally be what they should be—you in your own world, bending sound to your will. Lightweight design, toolless assembly, visually unique yet still functional, Lingo belongs in collaborative environments with you.



## DESIGNER PAUL JAMES

Paul James is an award winning designer and inventor with a reputation for both right and left-brain insight. He entered college to study engineering and emerged with degrees in math and economics. A graduate degree in industrial design led to leadership positions for several A list furniture companies. In 2002 he opened his own consultancy in Minneapolis specializing in product design and new venture start-ups. His process is equal parts head and hand, CAD and crayon, coffee and cocktail. Whether designing furniture, outdoor gear, or parametric fabrication systems, James' mantra is reason in every function and art in every detail.





# AVAILABLE COLOURS AND FINISHES

Lingo is constructed from the highest quality polyethylene terephthalate or P.E.T. An ideal material for reducing ambient noise and sound within noisy environments.

## COLOURS

 FOSSIL FL	 SUNSHINE SS	 FROST FT
 GREIGE GR	 MANDARINE MN	 CHAMBRAY CH
 CADET CT	 OCHRE OE	 SMOKE SE
 SKY SY	 BARK BR	 PEWTER PW
 COBALT CB	 ECRU EC	 SLATE SL
 MALACHITE MA	 LINEN LN	 TAR TR
 GRASS GS	 IVORY IY	

# PRIVACY HOODS

Protective but not smothering. Made from materials that reduce ambient sounds, the Lingo privacy hood is a spacious and safe haven designed for short term privacy. Make noise without hearing others. Make calls to whoever you want. Make faces. It's yours to do what you want with. With toolless assembly and lightweight design that attaches to interior walls, Lingo presents visual clarity without sacrificing function.

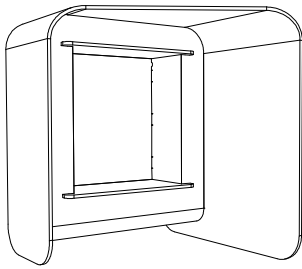

36" w X 36" h X 30" d

RIGHT  
FLPH3336R

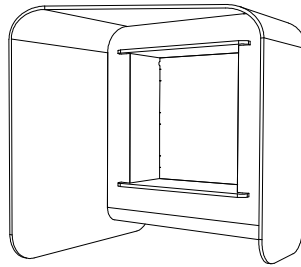

36" w X 36" h X 30" d

LEFT  
FLPH3336L



23" w X 32" h X .5" d

FLWP2436

# CONTACT

[funconnect.com](http://funconnect.com)



**CROWN**  
SURFACE SOLUTIONS

[crownsurfacesolutions.com](http://crownsurfacesolutions.com)

[info@crownsurfacesolutions.com](mailto:info@crownsurfacesolutions.com)

