

FUNC.

WHERE FUN AND FUNCTION CONNECT



ALINTA

FLOOR AND DESK SCREENS

FUNC.

Contract furniture doesn't have to be stuffy and uncreative. We know it can be stylish and modern and comfortable too. So we started making our own and never looked back.



FUNC.

ALINTA

Alinta has the screens you need for dividing personal and team spaces. Noisy environments don't stand a chance against our modern floor and desk screens. The vertical supports uphold sleek design, easy on the eyes, and never obtrusive. Alinta combines acoustic materials with wood accents seamlessly, while you work or play. High quality begets high quality, and creative work environments should be no exception.



DESIGNER PAUL JAMES

Paul James is an award winning designer and inventor with a reputation for both right and left-brain insight. He entered college to study engineering and emerged with degrees in math and economics. A graduate degree in industrial design led to leadership positions for several A list furniture companies. In 2002 he opened his own consultancy in Minneapolis specializing in product design and new venture start-ups. His process is equal parts head and hand, CAD and crayon, coffee and cocktail. Whether designing furniture, outdoor gear, or parametric fabrication systems, James' mantra is reason in every function and art in every detail.



AVAILABLE COLOURS AND FINISHES

Alinta is constructed from the highest quality polyethylene terephthalate or P.E.T. An ideal material for reducing ambient noise and sound within noisy environments.

Alinta is available with light or dark wood vertical supports and bases. A wood colour selection must be made when ordering.



FUNC.

COLOURS

FOSSIL FL	SUNSHINE SS	FROST FT
GREIGE GR	MANDARINE MN	CHAMBRAY CH
CADET CT	OCHRE OE	SMOKE SE
SKY SY	BARK BR	PEWTER PW
COBALT CB	ECRU EC	SLATE SL
MALACHITE MA	LINEN LN	TAR TR
GRASS GS	IVORY IY	

FINISHES

BLONDE B	DARK D
-------------	-----------

FLOOR SCREENS

A floor screen that reaches for the stars with you is a companion, without a doubt. Alinta floor screens are proof that design can be functional AND look good while doing it. Combining the finest acoustic materials with wood accents brings you ultimate ambient noise reduction for maximum privacy and uninterrupted workflow. Divide any personal or team space with the Alinta floor screen and conquer the day.

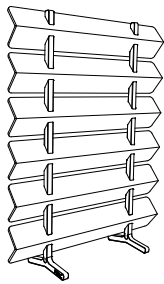

48" w x 61" h x 15" d

FALNFS4861

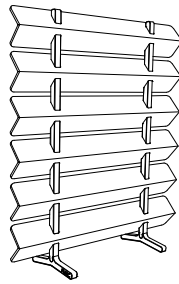

72" w x 61" h x 15" d

FALNFS7261

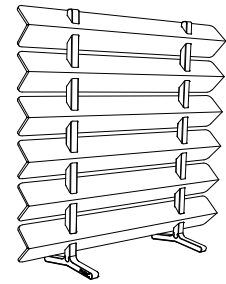

96" w x 61" h x 15" d

FALNFS9661

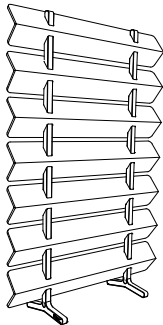

48" w x 72" h x 15" d

FALNFS4872

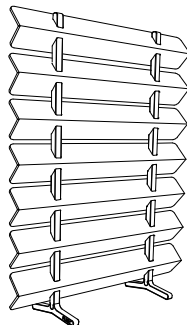

72" w x 72" h x 15" d

FALNFS7272

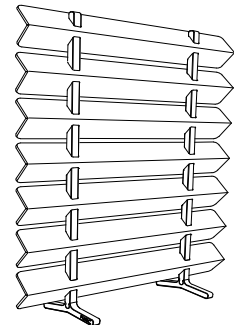

96" w x 72" h x 15" d

FALNFS9672

DESK SCREENS

The Alinta Desk Screen keeps creative environments thriving by reducing ambient sounds. The wood accents and acoustic materials create a killer combo in both design and function. The integrated cable management feature brings an extra layer of organization with simple and intuitive design. Peace of mind comes with the Alinta territory so that you can do what you do.

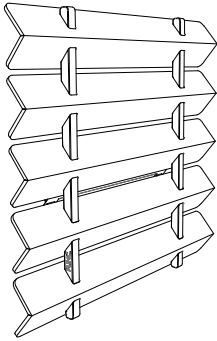

48" W X 43" H X 8" D

FALNDS4843

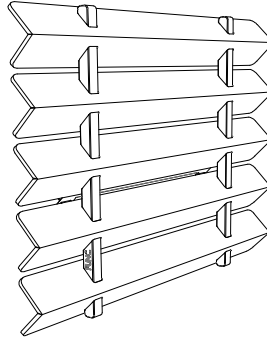

60" W X 43" H X 8" D

FALNDS6043

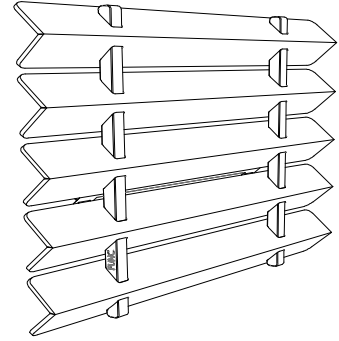

72" W X 43" H X 8" D

FALNDS7243

CONTACT

funconnect.com



crownsurfacesolutions.com
info@crownsurfacesolutions.com

